

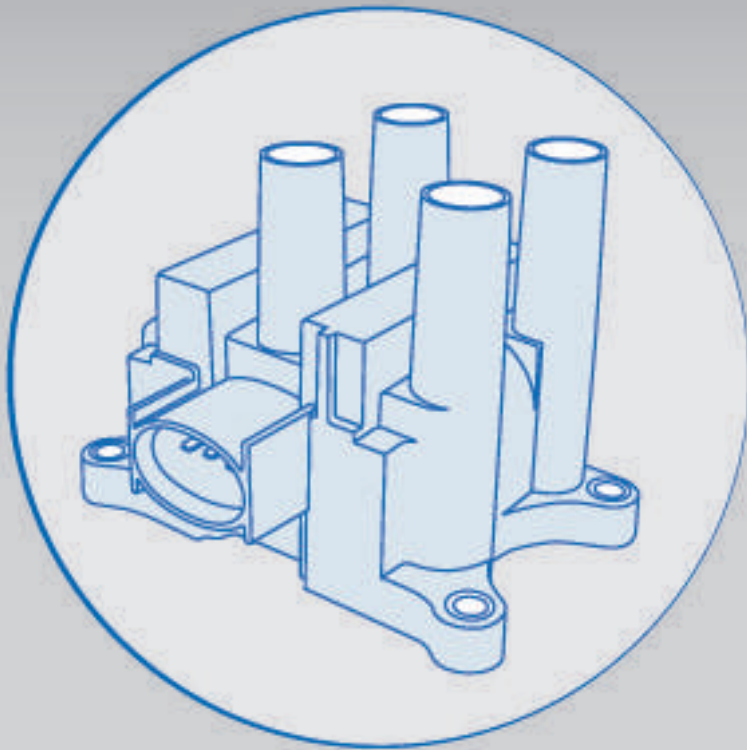

**Ignition Coil** / Bobina de Ignición



### AC DELCO

### GC4424

FEATURES / CARACTERÍSTICAS: 4 PIN / WITH IGNITION MODULE

REPLACES / REEMPLAZA:

GM: 12611424, 12570616; **Ac Delco:** 12611424; **Standard:** UF413, H6T55271ZC

APPLICATION / APLICACIÓN:

GM: Onix 1.0 / 1.4 LT/LTZ 2012>;

BUICK: Allure 2008, LaCrosse 2008>2009, Rainier 2006>2007;

CADILLAC: CTS 2006>2013, Escalade 2007>2013, Escalade ESV 2007>2013, Escalade EXT 2007>2013;

CHEVROLET: Avalanche 2007>2013, Camaro 2010>2013, Caprice 2011>2013, Cheyenne 2010>2013, Cheyenne 2500 2007>2009, Colorado 2007>2012, Corvette 2005>2013, Express 1500 2008>2013 /2500 2008>2013 /3500 2008>2013 /4500 2009>2012 /Cargo 2010>2012 /Pasajeros 2010>2012, Impala 2006>2009, Monte Carlo 2007, Silverado 1500 2007>2013 /2500 2007>2009 /2500 HD 2008>2013 /3500 2007>2009 /3500 HD 2008>2013, SSR 2005>2006, Suburban 1500 2007>2013 /2500 2007>2013, Tahoe 2007>2013, Trailblazer 2006>2009 /EXT 2005>2006;

GMC: Canyon 2009>2012, Envoy 2005>2009 /XL 2005>2006 /XUV 2005, Savana 1500 2008>2013 /2500 2008>2012 /3500 2008>2012 /4500 2009>2011, Sierra 2007>2012 /1500 2008>2013 /2500 HD 2008>2013 /3500 HD 2008>2013, Yukon 2007>2013 /XL 1500 2007>2013 /XL 2500 2007>2013;

HUMMER: H2 2008>2009, H3 2008>2010, H3T 2009>2010;

ISUZU: Ascender 2005>2006; PONTIAC: G8 2008>2009, Grand Prix 2006>2008, GTO 2005>2006; SAAB: 9-7x 2005>2009

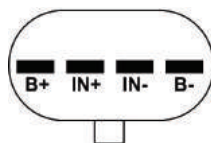

### AUDI / VW

### GC4115

FEATURES / CARACTERÍSTICAS: 4 PIN / WITH IGNITION MODULE

REPLACES / REEMPLAZA:

Audi/VW: 06A.905.115/S/D/R/Q, 06B.905.115H, 06B.905.115J

APPLICATION / APLICACIÓN:

AUDI: A3 96>12 1.8 (Turbo), A4 1.8 (Turbo), A6 1.8, TT 1.8 (Turbo);

SEAT: Ibiza 00>12, Leon 99>11, Cordoba 00>07, Skoda Octavia 1.8 (Turbo);

VW: Bora, Golf, New Beetle, Passat, Polo 1.8 (Turbo)

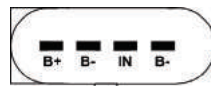

### BOSCH

### GC4000

FEATURES / CARACTERÍSTICAS: 3 PIN / WITH IGNITION MODULE

REPLACES / REEMPLAZA:

Bosch: 0 986 221 000; **Original code:** 6NO.905.104; **Magneti Marelli:** BI0015MM

APPLICATION / APLICACIÓN:

VW: GOLF III 1.8, 2.0, Polo Classic 1.8, 2.0;

AUDI: A80, 91-98, Seat Cordoba 1.0, 1.8 95-02, Ibiza 1.0, 1.8 95-02, Toledo 1.8

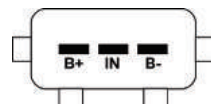

### BOSCH

### GC4001

FEATURES / CARACTERÍSTICAS: 3 PIN / WITH IGNITION MODULE

REPLACES / REEMPLAZA:

Bosch: 0 221 601 001; **VW:** 6N.090.510.5;

APPLICATION / APLICACIÓN:

AUDI: A3 >98;

SEAT: Cordoba 1.4/1.6 Todos;

VW: Golf, Logus, Passat Alemão 1.8, Pointer, Polo Classic >98

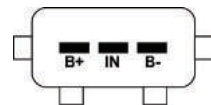

### BOSCH

### GC4006

FEATURES / CARACTERÍSTICAS: 3 PIN / WITH IGNITION MODULE

REPLACES / REEMPLAZA:

Bosch: 0 221 504 006; **Fiat:** 46.403.328; **Lancia:** 46.403.328

APPLICATION / APLICACIÓN:

FIAT: Coupé 2.0 20V 10/96>03/98, Coupé 2.0 20V Turbo 10/96>09/00, Marea 2.0 20V 10/96>02/99, Marea / Marea Weekend 2.0 20V 05/98>09/00, Marea / Marea Weekend 2.0 20V Turbo >00;

LANCIA: Kappa 96/10

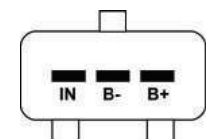

### BOSCH

### GC4007 // NEW //

FEATURES / CARACTERÍSTICAS: 2 PIN / WITHOUT IGNITION MODULE

REPLACES / REEMPLAZA:

Bosch: 0221502007, 0221502008

VW/Audi/Suzuki: 330905115A

Magneti Marelli: 060717001012

APPLICATION / APLICACIÓN:

VW: Santana 1994>2004

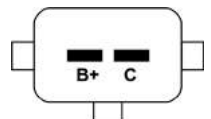

**BOSCH**

**GC4008 // NEW //**

FEATURES / CARACTERÍSTICAS: 4 PIN / WITH IGNITION MODULE

REPLACES / REEMPLAZA:

**Bosch:** 0 221 604 008; **Magneti Marelli:** BAE 680AR, BAE Q103; **Valeo:** 245175; **Delphi:** GN10334-12B1; **Volvo:** 9125601, 30713416.

APPLICATION / APLICACIÓN:

**Volvo:** C70 I Cabriolet, C70 I Coupé S60/ S70 (P80\_), S80 (TS, XY), V70 I Combi (P80\_), V70 II Combi (P80\_), XC70 CROSS COUNTRY, XC 90, **CHEVROLET:** CRUZE (J300) 1.6 09>

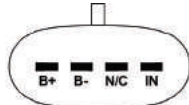

**BOSCH**

**GC4011 // NEW //**

FEATURES / CARACTERÍSTICAS: 4 PIN / WITHOUT IGNITION MODULE

REPLACES / REEMPLAZA:

**Bosch:** 221503011

**GM:** 90506102

**Opel:** 1208076

**Lucas:** DMB824

APPLICATION / APLICACIÓN:

**GM:** Vectra 1999>2002, Vectra 2.0 16V 1996>, Vectra 2.0 16V SFI 96>

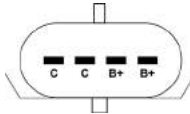

**BOSCH**

**GC4014**

FEATURES / CARACTERÍSTICAS: 3 PIN / WITHOUT IGNITION MODULE

REPLACES / REEMPLAZA:

**Bosch:** 0 221 504 014; **Fiat:** 46.467.542; Lancia 46.467.542

APPLICATION / APLICACIÓN:

**FIAT:** Coupé 2.0 20V 04/98>09/00, Marea 2.0 20V 03/99>09/02, Marea / Marea Weekend 2.0 20V Turbo 12/98>03/07, Marea / Marea Weekend 2.4 20V 07/00>05/05;

**LANCIA:** Kappa 07>10, Lybra 99>10, Thesis 02>09

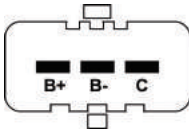

**BOSCH**

**GC4033**

FEATURES / CARACTERÍSTICAS: 3 PIN / WITHOUT IGNITION MODULE

REPLACES / REEMPLAZA:

**Bosch:** 0 221 503 018, 0 221 503 033; **MB:** 0 001 501 380, 000 150 12 80, 000 150 07 80

APPLICATION / APLICACIÓN:

**MERCEDES BENZ:** Classe A 1.6 (A160), Classe A 1.9 (A190) 05/99>05/05, Vaneo 1.6 /1.9 02>05

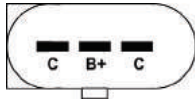

**BOSCH**

**GC4116**

FEATURES / CARACTERÍSTICAS: 2 PIN / WITHOUT IGNITION MODULE

REPLACES / REEMPLAZA:

**Bosch:** F 000 ZSO 116; **Original code:** 30510-PT2-006

APPLICATION / APLICACIÓN:

**HONDA:** Civic 1.6i 91-00, Prelude 2.2, 96-00, Accord 2.0, 2.2 93-02

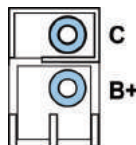

**BOSCH**

**GC4142**

FEATURES / CARACTERÍSTICAS: ASPHALT COIL - 2 TERMINALS

REPLACES / REEMPLAZA:

**Bosch:** 9 220 081 054; **Fiat:** 7507442, 4360771

APPLICATION / APLICACIÓN:

**FIAT:** 147 1300 /Fiorino /Pick-Up /City 01.73>04.88, Rallye 01.73>12.86, Elba 1.3 10.85>11.89, Fiorino 1.3 Furgão /Pick-Up 05.88>11.93, Oggi 1050 01.73>11.81, 1300 10.77>05.83, 1500 06.84>08.85, Panorama 03.80>05.83 /01.73>08.85 /1.3 01.73>11.86, Premio 1.3 03.85>09.92 / 03.85>12.88, 1.5 10.85>07.88, Spazio 1.3 01.73>08.84, Uno 1050 06.84>08.85 /1.3 06.84>09.91;

**FORD:** Belina 1.3 01.68>12.72 /1.4 01.73>12.77, Belina II 1.6 01.79>12.89, Corcel 1.3 01.68>12.72, 1.4 01.73>12.77, Corcel II 1.4 01.78>12.78 /1.6 01.79>06.83;

**VW:** Brasilia 1.3 10.73>12.82 /1.6 10.73>12.82, Fusca 1300 01.80>12.80 /1500 10.70>10.75 /1600 01.69>10.83, Puma GTE-GTS 01.70>12.79, Karmann Ghia 1600 01.70>12.72, Kombi 1.3 11.80>11.81, Passat 1.5 07.74>07.82 /1.6 06.81>12.83, Variant 12.69>12.77, Variant II 01.78>12.81, Voyage 1.5 06.81>12.83

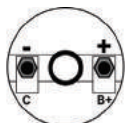

**BOSCH**

**GC4143**

FEATURES / CARACTERÍSTICAS: ASPHALT COIL - 4 TERMINALS

REPLACES / REEMPLAZA:

**Bosch:** 9 220 081 067; **Ford:** 542 905115, 84AU 12024 A, 305 905115 5; **GM:** 94 623 322; **VW:** 305 905 119 B, UF2

APPLICATION / APLICACIÓN:

**FIAT:** 147 1300 /Firoino /Pick-Up 83> 06.88, Oggi 1300 06.83>12.86, Panorama 06.83>12.86, Spazio 1.3 06.83>12.86;

**FORD:** Belina II 1.8 11.89>12.91, Corcel II 1.6 07.83>12.87, Del Rey 1.6 07.83>12.89 /1.8 08.89>12.91, Escort 1.3 08.83>08.92 /1.6 03.83>11.92 /1.8 06.89>11.92, F 1000 3.6 04.92>11.95, Pampa 1.6 /4X4 07.83>12.93, Royale 2.0i 02.92>08.93, Verona 1.6 01.90>11.92 /1.8 01.90>09.93, Versailles 2.0i 03.91>08.93;

**GURGEL:** BR 800 02.89>12.91;

**GM:** C20 03.92>10.95, Caravan 2.5 06.81>12.92 /4.1 10.74>12.92 /4.1S 10.84>12.89, Chevette /Hatch 1.4 06.74>08.87, 1.6 /S 08.82>12.89, Chevy 500 1.6 /S 08.82>12.89, Ipanema 1.8 08.89>02.91 /2.0 05.89>12.91 /Kadett 1.8 05.89>02.91 /GS 2.0 05.89>12.91, Marajo 1.4 74>08.87 /1.6 /S 08.82>12.89, Monza 1.6 /Hatch 01.84>12.86 /1.8 /Hatch 01.84>12.91 /2.0 /Hatch 10.86>12.91, Opala 2.5 01.71>12.92 /4.1 /S 01.71>12.92;

**VW:** Apollo 1.8 04.90>11.92, Fusca 1300 06.81>12.86 /1600 06.81>12.86, Gol 1.6 07.85>10.89 /1.8 02.84>08, Kombi 1.6 01.84>10.91, Parati 1.6 12.82>08.86, Passat 1.6 01.84>06.89 /1.8 01.84>06.89, Quantum 1.8 09.85>08.87 /2.0 09.85>08.87, Santana 1.8 02.84>08.87, /2.0 02.84>08.87, Saveiro 1.6 09.86>10.89, Voyage 1.5 06.81>12.83 /1.6 01.83>08.86

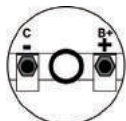

**BOSCH**

**GC4203**

FEATURES / CARACTERÍSTICAS: 3 PIN / WITHOUT IGNITION MODULE

REPLACES / REEMPLAZA:

**Bosch:** F 000 ZS0 200, F 000 ZS0 203; **GM:** 93.248.876

APPLICATION / APLICACIÓN:

**GM:** Astra 2.0 16V (SFI) 02/99>05/05, Sedan 1.8 (MPFI - gas.) 10/98>09/01 / 2.0 10/98>03/04, Astra, Zafira 2.0 (Flexp.) 04/04>, Astra. Sedan 1.8 (MPFI - álc.) 05/01>05/05, Astra Sedan 2.0 16V (SFI) 02/99>03/04, Astra, Sedan 2.0 Multipower (GNV+Flex) 10/04>, Vectra 2.0 8V (MPFI - gas.) 01/03>05/05 / 2.2 12/97>12/02, Vectra 2.2 16V (SFI) 12/97>05/05, Vectra GT, GTX SOHC (Flexp.) 09/07>, Vectra 2.0/2.4 8V (Flexp.) 10/05>, Zafira 2.0 16V 04/01>05/05 /1.8/2.0/2.4 16V 04/01>02/04

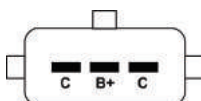

**BOSCH**

**GC4005**

FEATURES / CARACTERÍSTICAS: 3 PIN / WITHOUT IGNITION MODULE

REPLACES / REEMPLAZA:

**Bosch:** F 000 ZS0 202, F 000 ZS0 205; **GM:** 93.275.309

APPLICATION / APLICACIÓN:

**GM:** Ipanema 2.0 (MPFI) 04/96>11/97, Kadett 2.0 (MPFI) 12/96>12/98, Vectra CD 2.0 16V, Vectra GLS 2.0 (MPFI) 04/96>, Vectra GSI 2.0 16V 10/93>

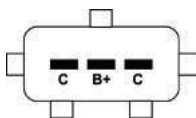

**BOSCH**

**GC4206**

FEATURES / CARACTERÍSTICAS: 3 PIN / WITHOUT IGNITION MODULE

REPLACES / REEMPLAZA:

**Bosch:** F000 ZS0 206, F000 ZS0 207; **Fiat:** 46752948; **Magneti Marelli:** MMBI0023

APPLICATION / APLICACIÓN:

**FIAT:** Dobló 1.3 Mpi 16V 01-06, Palio/ Siena/ Weekend 1.0/ 1.3 Mpi 16V, Fire 1.0 8V 01-05.

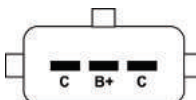

**BOSCH**

**GC4210**

FEATURES / CARACTERÍSTICAS: 4 PIN / WITH IGNITION MODULE

REPLACES / REEMPLAZA:

**Bosch:** F 000 ZS0 210, F 000 ZS0 209; **Original code:** 032.905.106B; **Magneti Marelli:** BI0017MM

APPLICATION / APLICACIÓN:

**AUDI:** A3 1.6 99-06;

**VW:** Fox 1.0, 1.4, 1.6 Total Flex 03>, Polo/ Sedan, Total Flex 04>, Gol III, IV, V 1.0 Mi, 1.0 Turbo, 1.6, 05>, Kombi 1.4 Total Flex 06>, Golf IV 1.6 06-08, Parati 1.0 Mi 16V

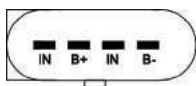

**BOSCH**

**GC4212**

FEATURES / CARACTERÍSTICAS: 3 PIN / WITHOUT IGNITION MODULE

REPLACES / REEMPLAZA:

**Bosch:** F 000 ZS0 212; **Cód. original:** 88SF-12029-A2A

APPLICATION / APLICACIÓN:

**FORD:** Courier 1.3, 1.4 97-99, Escort/ SW 1.8 /2.0 16V 98-02, Fiesta 1.0, 1.3, 1.4 96-99, Ka 1.0, 1.3 97-99, Ranger 2.3, 2.5i, 94-01

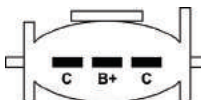

**BOSCH**
**GC4235**
**FEATURES / CARACTERÍSTICAS:** 3 PIN - WITHOUT SUPORT / WITHOUT IGNITION MODULE

**REPLACES / REEMPLAZA:**
**Bosch:** F 000 ZS0 235; **Fiat:** 55226876, 55230507

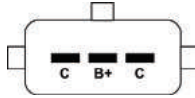
**APPLICATION / APLICACIÓN:**
**FIAT:** Uno 1.0 flex motor fire EVO 05.10>

**BOSCH**
**GC4243**
**FEATURES / CARACTERÍSTICAS:** 3 PIN - WITH SUPORT / WITHOUT IGNITION MODULE

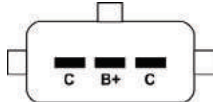
**REPLACES / REEMPLAZA:**
**Bosch:** F 000 ZS0 243; **Fiat:** 55229930

**APPLICATION / APLICACIÓN:**
**FIAT:** Doblo 1.8 MPI 16V/ Adventure Locker, Idea 1.6 16V /1.8 16V /Adventure, Palio 1.6 MPI 16V /1.8 MPI 16V Weekend Adventure, Punto 1.6 16V /1.8 16V, Siena 1.6 MPI 16V, Strada 1.8 MPI 16V (Todos Flex E.torQ 08.10>).

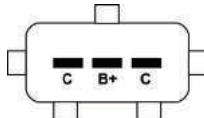
**BOSCH**
**GC4346**
**FEATURES / CARACTERÍSTICAS:** 3 PIN / WITHOUT IGNITION MODULE

**REPLACES / REEMPLAZA:**
**Fiat:** 7789346; **Bosch:** 0986221003

**APPLICATION / APLICACIÓN:**
**FIAT:** Brava 1.6 16V (MPI) 08/99>06/03, Doblò 1.6 16V (MPI) 11/01>08/03, Marea, Marea Weekend 1.6 16V (MPI) 06/05>, Palio 1.6 16V (MPI) 04/96>02/03, Palio Weekend 1.6 16V (MPI) 05/97>02/03, Siena 1.6 16V (MPI) 10/97>02/03, Strada 1.6 16V (MPI) 02/98>02/03

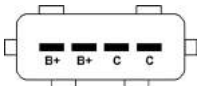
**BOSCH**
**GC4371 // NEW //**
**FEATURES / CARACTERÍSTICAS:** 4 PIN / WITHOUT IGNITION MODULE

**REPLACES / REEMPLAZA:**
**Bosch:** F 01R 00A 036, F 01R 00A 025

**APPLICATION / APLICACIÓN:**
**CHERY:** QQ 2012

**BOSCH**
**GC4372 // NEW //**
**FEATURES / CARACTERÍSTICAS:** 4 PIN / WITHOUT IGNITION MODULE

**REPLACES / REEMPLAZA:**
**Chery:** A11-3705110EA; **Bosch:** 0221503465

**APPLICATION / APLICACIÓN:**
**CHERY:** Tiggo, Riich V5, Eastar, A3, A5, SQR481 1.6L, SQR484 1.8L 2.0L engine; Chery A1, QQ6, SQR473 1.3L engine; Chery A5, E5, Fulwin2, Cowin, SQR477 1.5L engine; Chery Fulwin, Cowin, SQR480 1.6L engine; Buick Sail Epica; Chana CM5; **HAFEI:** Lobo, DA468, DA46.

**BOSCH**
**GC4407**
**FEATURES / CARACTERÍSTICAS:** 3 PIN / WITHOUT IGNITION MODULE

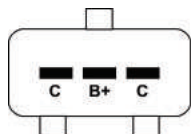
**REPLACES / REEMPLAZA:**
**Alfa Romeo:** 60558152, 60809606; **Bosch:** 0 221 503 407; **Ferrari:** 134386, 7648797; **Land Rover:** ERR6045, ERR6566; **VW:** 48.905.105.1

**APPLICATION / APLICACIÓN:**
**ALFA ROMEO:** 155 2.0 92-96, 164 2.0 92-98;  
**FIAT:** Tipo 1.6 IE, 1.6 Mpi 93-97, Uno 1.6 Mpi 94-95, Fiorino 1.6Mpi 95-96;  
**VW:** Gol/ Parati II/ III, 2.0 Mi 16V Gti 95-00;  
**LAND ROVER:** Discovery/ Range Rover 4.0 94-04

**BOSCH**
**GC4421**
**FEATURES / CARACTERÍSTICAS:** 3 PIN / 2 COILS / WITHOUT IGNITION MODULE

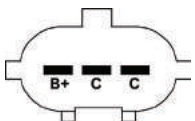
**REPLACES / REEMPLAZA:**
**Bosch:** 0 986 221 004; **Hyundai:** 27301-22040, 27301-22050; **Standard:** UF176; **Wells:** C1113; **USA Group:** C1113, UF178; **Beru:** 0040100264

**APPLICATION / APLICACIÓN:**
**HYUNDAI:** Accent L4-1.5L 1995>1999, Accent 1.3 1994>2000, Excel 1.3

**BOSCH**

**GC4485**

FEATURES / CARACTERÍSTICAS: 3 PIN / WITHOUT IGNITION MODULE

REPLACES / REEMPLAZA:

**Bosch:** 0 221 503 485, 0 221 503 487; **Ford:** 4M5G12029ZA, 4M5G12029ZB, FOCUS 1352562, 1459278, 1350562; **Volvo:** 30731416, 30731419, 31216444, 31216444-AA, 4S7G-12029-AB

APPLICATION / APLICACIÓN:

**FORD:** Courier /Van 1.6i, EcoSport 1.6i, Fiesta 1.0i /Sedan /1.6i /Sedan, Focus 1.6i 8V /Sedan, Ka 1.0i /1.6i (Todos Flex Zetec Rocam 01.08>), Mondeo 1.8L

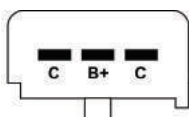

**BOSCH**

**GC4490 // NEW //**

FEATURES / CARACTERÍSTICAS: 3 PIN / WITHOUT IGNITION MODULE

REPLACES / REEMPLAZA:

**Mazda:** L813-18-100

APPLICATION / APLICACIÓN:

**Ford:** Fiesta Mk IV / V, Fiesta Van, Escort Mk VII, Courier 1.3, Ka 1.3i, Street Ka, Mondeo Mk II / III, Puma, Cougar, Focus, Escape, Fusion, **Mazda:** Demio



**BOSCH**

**GC4504**

FEATURES / CARACTERÍSTICAS: 2 PIN / WITHOUT IGNITION MODULE

REPLACES / REEMPLAZA:

**Bosch:** 9 220 081 504, F 000 ZSO 105; **Magneti Marelli:** BI0016MM

APPLICATION / APLICACIÓN:

**VW:** Gol, Parati, Quantum, Santana, Saveiro

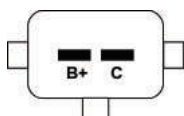

**BOSCH**

**GC4505 // NEW //**

FEATURES / CARACTERÍSTICAS: 3 PIN / WITH SUPORT / WITHOUT IGNITION MODULE

REPLACES / REEMPLAZA:

**Bosch:** 9 220 081 505; **Magneti Marelli:** BAE 504L, BAE Q020, BI0047MM; **Renault:** 7 700 749 450, 7 702 205 459, 7 702 218 697; **Delphi:** CE20053-12B1.

APPLICATION / APLICACIÓN:

**RENAULT:** CLIO 1.6 8V 96-99, R19 1.6 8V 93-00, TRAFIC 1.6 8V 93-00, TWINGO 1.2i 93-97.

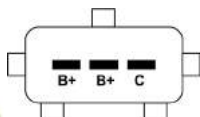

**BOSCH**

**GC4506**

FEATURES / CARACTERÍSTICAS: 3 PIN / WITH IGNITION MODULE

REPLACES / REEMPLAZA:

**Bosch:** F000 ZSO 104, 9 220 081 506; **VW:** 377 905 105B

APPLICATION / APLICACIÓN:

**VW:** Gol II 1.0 8V 98-05, Kombi 1.6 Mpi, 98-05

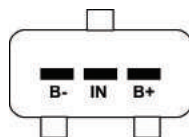

**BOSCH**

**GC4509**

FEATURES / CARACTERÍSTICAS: 4 PIN / WITHOUT IGNITION MODULE

REPLACES / REEMPLAZA:

**Bosch:** 9 220 081 509

APPLICATION / APLICACIÓN:

**GM:** Ipanema, Kadett, Monza 1.8 /2.0 Efi 91-97.

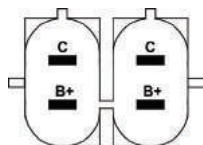

**BOSCH**

**GC4510**

FEATURES / CARACTERÍSTICAS: 4 PIN / WITHOUT IGNITION MODULE

REPLACES / REEMPLAZA:

**Bosch:** 9 220 081 510; **Delphi:** CE10510; **GM:** 93.230.799; **Magneti Marelli:** BI0011MM

APPLICATION / APLICACIÓN:

**GM:** Corsa 1.0/1.4 (EFI) 04/94>12/96

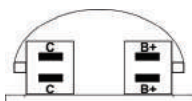

### BOSCH

#### GC4602 // NEW //

FEATURES / CARACTERÍSTICAS: 2 PIN / WITHOUT IGNITION MODULE

REPLACES / REEMPLAZA:

**Bosch:** 022506002, 0221506003, 0221506444, 0221506445;

**Mercedes Benz:** 0001587003, 0001587103;

**Daewoo:** 0001587003, 0001587503;

**Volkswagen:** 00A905105;

**Skoda:** 00A 905 105;

**Delphi:** CE20038-12B1

APPLICATION / APLICACIÓN:

**Mercedes Benz:** E-Class, SL, S-Class, C-Class, G-Class, SLK, Coupe, Saloon, Kombi, C230, C280, C36 AMG, E320, S320, SL320, 300CE, 300E, 300TE.

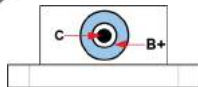

### BOSCH

#### GC4213

FEATURES / CARACTERÍSTICAS: 3 PIN / WITHOUT IGNITION MODULE

REPLACES / REEMPLAZA:

**VW:** 026 905 105; **BOSCH F 000 ZS0 213**

APPLICATION / APLICACIÓN:

**VW:** Gol III 1.6Mi Flex 05.03-08.05 / 1.8Mi Flex 02.05-08.05, Gol IV 1.6 Flex 08.05-06.08 / 1.8 Flex 08.05-06.08, Parati III 1.6Mi Flex 05.03-8.05 / 1.8Mi Flex 02.05-08.05, Parati IV 1.6 Flex 09.05 / 1.8 Flex 09.05-12.08, Saveiro III 1.6Mi Flex 05.03-08.05 / 1.8Mi Flex 02.05-08.05, Saveiro IV 1.6 Flex 09.05-08.09 / 1.8 Flex 09.05-08.09

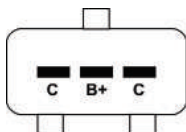

### BOSCH

#### GC4715 // NEW //

FEATURES / CARACTERÍSTICAS: 4 PIN / WITH IGNITION MODULE

REPLACES / REEMPLAZA:

**Bosch:** 0986221023;

**VW/Audi/Skoda/Seat:** 036905715, 036905715A/C/E/F/G, 036905100A/B/C/D;

**Delphi:** CE20030-12B1;

**Magneti Marelli:** BAE408AE/245, BAE680AU, 060801016010;

**Valeo:** 245141;

**Lucas:** DMB807

APPLICATION / APLICACIÓN:

**VW:** Golf IV Estate, Golf IV, Jetta IV, Jetta IV Estate, Polo, New Beetle Convertible, Touran, Rabbit V, Bora, Caddy, CC, EOS, Lupo, Passat, Scirocco, Sharan, Tiguan;

**Audi:** A1, A2, A3, A4 1.4/1.6/2.0 with motor FSI and TFSI;

**Seat:** Alhambra, Altea, Altea XL, Arosa, Cordoba, Ibiza, Inca, Leon, Toledo;

**Skoda:** Fabia, Octavia, Rapid, Roomster, Roomster Praktik, Superb, Yeti.

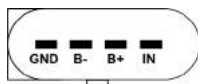

### BOSCH

#### GC4800

FEATURES / CARACTERÍSTICAS: 3 PIN / WITH IGNITION MODULE

REPLACES / REEMPLAZA:

**Nissan:** 22448-ED800, 22448-ED800EP, 22448-C100A; **Bosch:** 0 221 604 014, 0 221 604 015, 0 221 604 020, 1 220 703 040;

**Renault:** 7701065086; **Standard:** UF-591; **Beru:** 0040102506

APPLICATION / APLICACIÓN:

**NISSAN:** Sentra 2.0 10.06>04.09, Tiida 1.8 Hatchback 03.07>

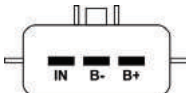

### BOSCH

#### GC4801 // NEW //

FEATURES / CARACTERÍSTICAS: 3 PIN / WITHOUT IGNITION MODULE

REPLACES / REEMPLAZA:

**Renault:** 8200699627; **Bosch:** 0221504030

APPLICATION / APLICACIÓN:

**RENAULT:** Fluence 2.0 16V flex, zGrand Scenic 2.0 16V 09>, Latitude 2.0 16V 11>, Megane CC 2.0 CVT 10>, Megane Coupe 2.0 16V 08>, Megane Estate 2.0 16V 09>, Megane Hatchback 08>

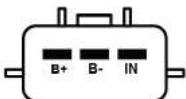

### BOSCH

#### GC4802

FEATURES / CARACTERÍSTICAS: 2 PIN / WITHOUT IGNITION MODULE

REPLACES / REEMPLAZA:

**Bosch:** 0 221 500 802

APPLICATION / APLICACIÓN:

**JAC;** BYD;

**MITSUBISHI:** Carisma 1.8 16V GDI DA2A 1997-2006 / 1.8 GDI DA2A 1997-2003 / Saloon 1.8 GDI DA2A 1999-2003, Shogun Pinin 1.8 2002-2006, Space star 1.8 GDI DG5A 1998-2004

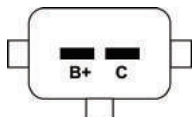

### CHRYSLER

#### GC4138 // NEW //

FEATURES / CARACTERÍSTICAS: 2 PIN / WITHOUT IGNITION MODULE

REPLACES / REEMPLAZA:

Chrysler: 56028138, 56028138-AD/AF/AB;

Standard: UF270, UF297;

Wells: C1231

APPLICATION / APLICACIÓN:

Chrysler: Aspen;

Dodge: Dakota, Durango, Nitro, Ram 1500;

Jeep: Commander, Grand Cherokee, Liberty;

Mitsubishi: Raider.

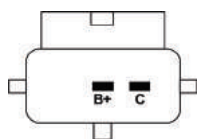

### CHRYSLER

#### GC4423 // NEW //

FEATURES / CARACTERÍSTICAS: 2 PIN / WITHOUT IGNITION MODULE

REPLACES / REEMPLAZA:

Chrysler: 4751253, 5234210, 5234610, 5252577, 4797293, 90048-52091-000;

GM: 19017110;

Delco: C506;

Lucas: DMB968;

Standard: UF97

APPLICATION / APLICACIÓN:

Chrysler: Daytona, Dynasty, Lebaron, Grand Cherokee V8;

Plymouth: Acclaim, Sundance, Grand Voyage, Trucks;

Dodge: Trucks;

Jeep: Wrangler (6 Cilindros), Stratus

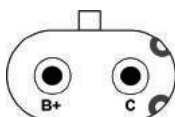

### CITROËN

#### GC4095

FEATURES / CARACTERÍSTICAS: 4 PIN / WITHOUT IGNITION MODULE

REPLACES / REEMPLAZA:

Valeo: 245095; Citroën: 597080;

APPLICATION / APLICACIÓN:

CITROËN: C3 1.6 16V, Xsara, Xsara Break, Xsara Picasso 1.6 16V 02>;

PEUGEOT: 206, 307 1.6 16V

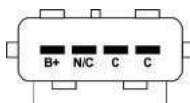

### DAEWOO

#### GC4578

FEATURES / CARACTERÍSTICAS: 4 PIN / WITHOUT IGNITION MODULE

REPLACES / REEMPLAZA:

Daewoo: 96291054; OEM: 51578; CSA: 96291054

APPLICATION / APLICACIÓN:

CHEVROLET: Matiz 0.8 03.2005>, Spark 0.8 2005>2013, CMV (Van);

DAEWOO: Matiz 0.8 1998>2005, Damas (Van)

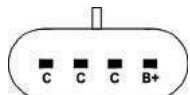

### DAEWOO

#### GC4579 // NEW //

FEATURES / CARACTERÍSTICAS: 2 PIN / WITHOUT IGNITION MODULE

REPLACES / REEMPLAZA:

Daewoo: 33410A60B30-000, Y3C, 94582699

APPLICATION / APLICACIÓN:

Daewoo: Tico

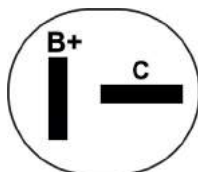

### DELPHI

#### GC4038

FEATURES / CARACTERÍSTICAS: 4 PIN / WITH IGNITION MODULE

REPLACES / REEMPLAZA:

Delphi: DF20013; GM: 01104038, 10450424, 10490192; Magneti Marelli: BI0013MM

APPLICATION / APLICACIÓN:

GM: Corsa 1.0 /1.4 /1.6

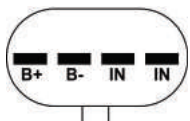

**DELPHI**
**GC4133 // NEW //**
**FEATURES / CARACTERÍSTICAS:** 6 PIN / WITHOUT IGNITION MODULE

**REPLACES / REEMPLAZA:**
**Fiat:** FTP 55228006;

**Delphi:** CE20132

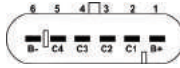
**APPLICATION / APLICACIÓN:**
**Fiat:** Uno Vivace 1.4

**DELPHI**
**GC4483**
**FEATURES / CARACTERÍSTICAS:** 3 PIN / WITHOUT IGNITION MODULE

**REPLACES / REEMPLAZA:**
**Daewoo/GM:** 93 363 483, 96 253 555; **Delphi:** CE10001; **Opel:** 19005265; **Bosch:** F000ZS0222

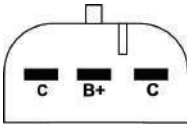
**APPLICATION / APLICACIÓN:**
**GM:** Celta 1.0/1.4 8V 00>, Corsa/ Sedan, 1.4, 1.8 MPFi 02>, Meriva 1.4, 1.8 02>, Montana 1.4/1.8, 03, Prisma 1.4 06>;

**FIAT:** Stilo, Palio, Siena, Idea, Dobló, Strada, Punto 1.8 8V.

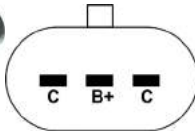
**DELPHI**
**GC4373 // NEW //**
**FEATURES / CARACTERÍSTICAS:** 3 PIN / WITHOUT IGNITION MODULE

**REPLACES / REEMPLAZA:**
**Effa:** GDQ170; **Delphi:** 19005270

**APPLICATION / APLICACIÓN:**
**HAFEI:** Minyi Minz, Chana, Changhe, Shuanghuan CEO, Tianma pickup, Geely Meiri CK Emgrand EC7 View Englan SC7, Hafei Minyi, Chevrolet Spark, Great Wall Haval, Lifan 520; **Geely 4G15 engine, DA465, B12.**
**ASIA MOTORS:** Towner EFFA

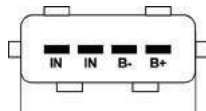
**DELPHI**
**GC4905**
**FEATURES / CARACTERÍSTICAS:** 4 PIN / WITH IGNITION MODULE

**REPLACES / REEMPLAZA:**
**Delphi:** BID 00001; **Magneti Marelli:** BI0012MM; **GM:** 1103905; **Cód. Original:** 01 103 905, 10 457 075; **Bosch:** F 000 ZS9 200

**APPLICATION / APLICACIÓN:**
**GM:** Blazer, Corsa, S10

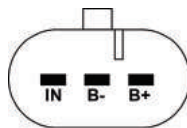
**DELPHI**
**GC4913**
**FEATURES / CARACTERÍSTICAS:** 3 PIN / WITH IGNITION MODULE

**REPLACES / REEMPLAZA:**
**Delphi:** 28063913, 19005277; **JAC:** PHC28063913, 1A14, 120421

**APPLICATION / APLICACIÓN:**
**JAC:** J2, J3, J5 1.4/1.5

**DELPHI**
**GC4927**
**FEATURES / CARACTERÍSTICAS:** 7 PINOS / LONG BOOT / WITH IGNITION MODULE

**REPLACES / REEMPLAZA:**
**GM:** 55584404, 96476983; **Opel:** 1208098; **Delphi:** 28326927; **Airtex:** 5C1703; **Carquest:** 522058; **Standard:** UF620;

**Wells:** C1646

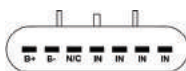
**APPLICATION / APLICACIÓN:**
**GM:** Cruze 1.8 2011>, Sonic 1.6 16V 2013, Aveo L4-1.6L 2009>2011, Aveo5 L4-1.6L 2009>2011; **OPEL:** Astra GTC J 1.8 103Kw 140CV 796cc, Astra H Caravan 1.6 85Kw 116CV 1598cc, Astra J 1.6 85Kw 115CV 1598cc, Astra J Stufenheck 1.6 85Kw 116CV 1598cc, Astra Sports Tourer (J) 1.6 85Kw 116CV 1598cc /1.6 LPG 84Kw 114CV 1598cc, Insignia 1.6 85Kw 116CV 1598cc /1.8 103Kw 140CV 1796cc, Insignia Sports Tourer 1.6 85Kw 116CV 1598cc /1.8 103Kw 140CV 1796cc, Insignia tufenheck 1.6 85Kw 116CV 1598cc /1.8 103Kw 140CV 1796cc, Mokka 1.6 85Kw 116CV 1598cc, Zafira B (A05) 1.8 103Kw 140CV 1796cc, Zafira B Van 1.8 103Kw 140CV 1796cc, Zafira C (P12) 1.8 103Kw 140CV 1796cc /1.8 LPG 101Kw 137CV 1796cc;

**PONTIAC:** G3 L4-1.6L 2009>2010, G3 Wave L4-1.6L 2009

IGNITION COIL

### DENSO

#### GC4101 // NEW //

FEATURES / CARACTERÍSTICAS: 3 PIN / WITH IGNITION MODULE

REPLACES / REEMPLAZA:

DENSO: 099700-101;  
HONDA: 30520-RNA-A01;  
STANDARD: UF582

APPLICATION / APLICACIÓN:  
Honda: New Civic 06>

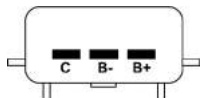

### DENSO

#### GC4181 // NEW //

FEATURES / CARACTERÍSTICAS: 3 PIN / WITH IGNITION MODULE

REPLACES / REEMPLAZA:

Denso: 099700-181, 099700181

APPLICATION / APLICACIÓN:  
Honda: New Civic

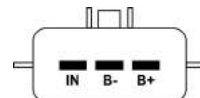

### DENSO

#### GC4239 // NEW //

FEATURES / CARACTERÍSTICAS: 4 PIN / WITH IGNITION MODULE

REPLACES / REEMPLAZA:

Denso: 90919-02239; Bosch: F 005 X11 783; Magneti Marelli: BAE Q126; Valeo: 245178; Delphi: GN10314

APPLICATION / APLICACIÓN:

TOYOTA: COROLLA 1.6i 16V Sedan gas 02-09/ 1.8i 16V Sedan Flex 2008>/ 1.8i 16V Sedan gas 02-08, Fielder 1.8i 16V Wagon gas 04-07.



### DENSO

#### GC4252 // NEW //

FEATURES / CARACTERÍSTICAS: 4 PIN / WITH IGNITION MODULE

REPLACES / REEMPLAZA:

Toyota / Denso: 90919-02252, 90919-02258, 90919-C2003, 90919-C2005;

Standard: UF619

APPLICATION / APLICACIÓN:

Pontiac: Vibe; Scion: XD; Toyota: Corolla, Matrix, Prius.  
Lexus: CT200H

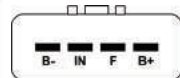

### DENSO

#### GC4273

FEATURES / CARACTERÍSTICAS: 2 PIN / WITHOUT IGNITION MODULE

REPLACES / REEMPLAZA:

Denso: 27301-2B000

APPLICATION / APLICACIÓN:

HYUNDAI: i30 1.4 / 1.6 2007>2011;  
KIA: Cerato 1.6 2004>, Soul 2009>

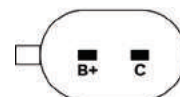

### DENSO

#### GC4420

FEATURES / CARACTERÍSTICAS: 2 PIN / 2 COILS / WITHOUT IGNITION MODULE

REPLACES / REEMPLAZA:

Denso: 01122-0210; Hyundai / KIA: 27301-22600; Standard: UF308; Wells: C1350; MSW LT-C1350

APPLICATION / APLICACIÓN:

DODGE: Verna L4-1.6L 2004>2006;

HYUNDAI: Accent 1995>2003, Accent 2000>2003 L4-1.5L, Accent L4-1.6L 2003



### FORD

#### GC4010 // NEW //

FEATURES / CARACTERÍSTICAS: 3 PIN / WITHOUT IGNITION MODULE

REPLACES / REEMPLAZA:

Mazda: L813-18-100

APPLICATION / APLICACIÓN:

Ford: Fiesta Mk IV / V, Fiesta Van, Escort Mk VII, Courier 1.3, Ka 1.3i, Street Ka, Mondeo Mk II / III, Puma, Cougar, Focus, Escape, Fusion;  
Mazda: Demio

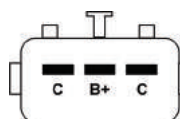

**FORD**

**GC4016**

FEATURES / CARACTERÍSTICAS: 2 PIN / WITHOUT IGNITION MODULE

REPLACES / REEMPLAZA:

Ford: F7TU-12A336-AB, 3W7E-12A366-AA, F7TZ-12029-AB, IL2U-12029-AA, IL2Z-12029-AA, F7TZ-12A366-BA, F7TZ-12029-BA, F7TZ-12029-CC, F7TZ-12029-CA, F7TZ-12A366-AB, 3W7Z-12029-AA DG508, DG491, DG467, DG472

APPLICATION / APLICACIÓN:

FORD E-150, E-250, F-150, E-350 /F-250 /F-350 /F-450/F-550 Super Duty, Crown Victoria, Mustang, Expedition, Excursion, E-150 /E-250 /E-350 Econoline (98-2000);

LINCOLN: Town Car, Navigator (98-2000);

MERCURY: Grand Marquis (98-2000)

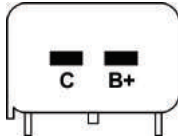

**FORD**

**GC4030 // NEW //**

FEATURES / CARACTERÍSTICAS: 3 PIN / WITHOUT IGNITION MODULE

REPLACES / REEMPLAZA:

Ford: 988F12029-AC, 1S7Z12029-AD, 988F12029-AB, 988F12029-AD, 1067601, 1075786, 1130402, 1317972, 1319788, 1119835;

Delphi: CE20119;

Mazda: 1E04-18-10X, 1E05-18-100B, YF09-18-10X, 1F20-18-100, LF01-18-100;

Lucas: DMB805;

Magneti Marelli: BI0020MM

APPLICATION / APLICACIÓN:

Ford: Fiesta, Ecosport, Courier, Escort, Focus, Ka, Mondeo, Kadett

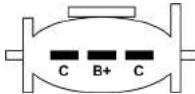

**FORD**

**GC4031 // NEW //**

FEATURES / CARACTERÍSTICAS: 3 PIN / WITHOUT IGNITION MODULE

REPLACES / REEMPLAZA:

Ford: CM5G-12029-FC

APPLICATION / APLICACIÓN:

Ford: Ecosport, Fiesta, Focus, KA 1.6, Sigma

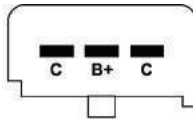

**FORD**

**GC4140**

FEATURES / CARACTERÍSTICAS: 2 PIN / OIL COIL / WITHOUT IGNITION MODULE

REPLACES / REEMPLAZA:

Ford: FD476, FD476T, FD476X, C832, 3230427, 33004522, 8933004522, D5AZ-1209-A, DG314, F502, F502Z, FO400, J3230427, 9224771015

APPLICATION / APLICACIÓN:

FORD: Fairmont V6 1983, Thunderbird 1985>1989, Trucks F150 1985>1989, Trucuk&Vans 1975>1987;

MERCURY: 1975>1986, Cougar V-6 1985>1989, Topaz 1984>1989;

NISSAN: Tsuru II 1988>1992; AMC: 1977>1987, Eagle 1988;

JEEP: 1978>1991; LINCOLN: 1975>1984;

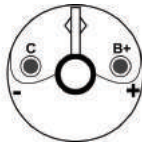

**FORD**

**GC4366 // NEW //**

FEATURES / CARACTERÍSTICAS: 2 PIN / WITHOUT IGNITION MODULE

REPLACES / REEMPLAZA:

Ford: 12A366-BA/B/C, 4W5G-12A366-BA, 4M5G-12A366-BB, 4M5G-12A366-BC, 4M5Z-12029B, 1224925, 1314271, LF16-18-100B;

Wells: C1453

APPLICATION / APLICACIÓN:

Ford: Focus 2.0 2003~2007, Ecosport 2.0 Duratec, Transit Connect, Escape;

Mazda: Tribute

Mercury: Mariner



**FORD/MAZDA**

**GC4019**

FEATURES / CARACTERÍSTICAS: 2 PIN / WITHOUT IGNITION MODULE

REPLACES / REEMPLAZA:

E1EF12029AA, E2FZ12029A, E3FZ12029A, E73F12029AA, AB, E73Z12029A, E32Z12029A, 12321405, 12336833, 19017194, F-503, F-1953, 1694979-C1, F-515-18-10X, ZZMI-18-100, ZZM4-18-100, F3FU 12029AA, E2EF 12029AA, E3EF 12029AA, F32Z-12029-A, FD478X, DG434, DG-325A, DG-325AD, DGE-453

APPLICATION / APLICACIÓN:

FORD: EXP 83-88, V6 3.0L 90-97, Taurus 86-95, Tempo 85-94;

MAZDA: 626 94-97, MX-6 94-97, pickup 94;

MERCURY: Capri 83-86, Colony Park 85-91

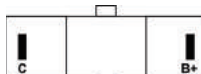

**GM**

**GC4012**

FEATURES / CARACTERÍSTICAS: 6 PIN / WITH IGNITION MODULE

REPLACES / REEMPLAZA:

GM: 19 005 212; Fiat: 47.905.104

APPLICATION / APLICACIÓN:

FIAT: Stilo 1.8 16V;

GM: Astra 1.6 16V, Meriva 1.8 16V

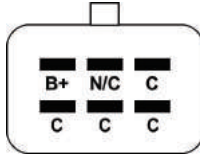

**GM**

**GC4015**

FEATURES / CARACTERÍSTICAS: 2 TERMINALS / WITHOUT IGNITION MODULE

REPLACES / REEMPLAZA:

GM: D539, D540, D555, 1103608, 1103646, 1103662, 1103663, 1103744, 1103745, 1103746, 10468391, 10472401, 10497771, 10495121; Isuzu: 8-10468-391-0

APPLICATION / APLICACIÓN:

GM: Corvette 90-95, Impala 00-05, LLV (Postal vehicle) 94-95, S10 Pickup 94-03, Lumina 90-01, Lumina APV 92-96, Malibu/Malibu Maxx 97-03, Monte Carlo 95-05, Venture97-05, Oldsmobile Toronado 86-92

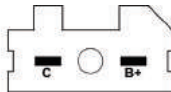

**GM**

**GC4017**

FEATURES / CARACTERÍSTICAS: 3 TERMINALS / WITHOUT IGNITION MODULE

REPLACES / REEMPLAZA:

GM: D530, D532, D523, 8131936, J8131936, 1875894, 1985473, 10497132, CONP12029A, DGG-419, 1694925-C1, IDO-4002S

APPLICATION / APLICACIÓN:

CHRYSLER /GM: American Motors Concord 80-81, Corvette 74-81, El Camino 74-87, Impala 74-85, Laguna 74-76, Astro 85, Fullsize Pickup 75-89, G Series Fullsize Van /Express 75-88, P Series Van 75/89, Pontiac Parisienne 77-86, Pontiac Ventura 77

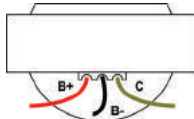

**GM**

**GC4021**

FEATURES / CARACTERÍSTICAS: 4 TERMINALS / WITHOUT IGNITION MODULE

REPLACES / REEMPLAZA:

GM: D525, D527, D528, D529 1187847, 8134003, J8134003, 1115444, 1115445, 1115447, 1115449, 1115460, 1115448, 1115455, DGG-222, DGG-322, DGG-421, 5-73, 5-74

APPLICATION / APLICACIÓN:

GMC TRUCK: 75-77, 82-84;

CHEVROLET TRUCK: 75-77, 82-84;

OLDSMOBILE: 75-77, 81-84

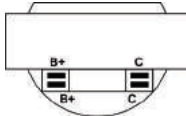

**GM**

**GC4062**

FEATURES / CARACTERÍSTICAS: 3 PIN / WITH IGNITION MODULE

REPLACES / REEMPLAZA:

GM: 12568062; Standard: UF303; OEM: 43420000, 8-12568-062-0

APPLICATION / APLICACIÓN:

BUICK: Rainier 2004>2005; CHEVROLET: Blazer 2002, Colorado 2004>2006, Trailblazer 2002>2005 /EXT 2002>2005;

GMC: Canyon 2004>2006, Envoy 2002>2005 /XL 2002>2005 /XUV 2004>2005;

HUMMER: H3 2006; ISUZU: Ascender 2003>2008, i-280 2006, i-290 2007>2008, i-350 2006, i-370 2007>2008;

OLDSMOBILE: Bravada 2002>2004; SAAB: 9-7x 2005

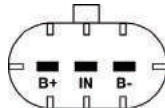

**GM**

**GC4141 // NEW //**

FEATURES / CARACTERÍSTICAS: COIL BY OIL - 2 PIN / WITH RESISTOR / WITHOUT IGNITION MODULE

REPLACES / REEMPLAZA:

UC12, C831, 90919-02111, DQ132, GT-63

APPLICATION / APLICACIÓN:

Universal

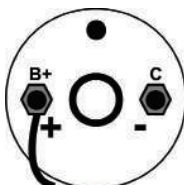

**GM**
**GC4265**
**FEATURES / CARACTERÍSTICAS:** 3 PIN / WITHOUT IGNITION MODULE

**REPLACES / REEMPLAZA:**
**DELPHI:** CE20130; **GM:** 94716808

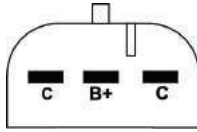
**APPLICATION / APLICACIÓN:**
**GM:** Celta /Corsa /Meriva /Montana /Prisma 8V flex

**GM**
**GC4298**
**FEATURES / CARACTERÍSTICAS:** 5 PIN / WITH IGNITION MODULE

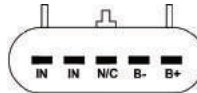
**REPLACES / REEMPLAZA:**
**DELPHI:** CE20131; **GM:** 24580298QTY, 94702536

**APPLICATION / APLICACIÓN:**
**GM:** Agile 1.4, Cobalt, S10 8V Flex 2009~2012

**GM**
**GC4422 // NEW //**
**FEATURES / CARACTERÍSTICAS:** 3 PIN / WITHOUT IGNITION MODULE

**REPLACES / REEMPLAZA:**
**GM:** D-577, 10489421;

**Isuzu:** 8-10489-421-0;

**Standard:** DR49

**APPLICATION / APLICACIÓN:**
**GM:** Blazer 4.3 V6, S10 4.3 V6;

**Buick:** Roadmaster;

**Cadillac:** Escalade, Fleetwood;

**Chevrolet:** Astro Van, Camaro, Caprice, Express Van, Pickup Truck, Tahoe;

**GMC:** Pickup Truck, Jimmy, Safari Van, Savana Van, Sonoma Pickup Truck, Yukon;

**Isuzu:** Hombre Pickup Truck;

**Oldsmobile:** Bravada;

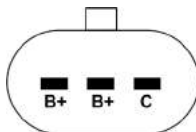
**Pontiac:** Firebird

**GM**
**GC4547 // NEW //**
**FEATURES / CARACTERÍSTICAS:** 2 PIN / WITHOUT IGNITION MODULE

**REPLACES / REEMPLAZA:**
**GM:** 10457109, 10472748, 10474481, D547, D550, D583;

**Standard:** DR41

**APPLICATION / APLICACIÓN:**
**Chevrolet:** Beretta, Cavalier;

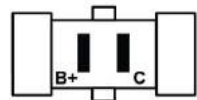
**Pontiac:** Grand Am, Grand Prix, Sunfire, Tempest;

**Buick:** Skylark

**GM**
**GC4824 // NEW //**
**FEATURES / CARACTERÍSTICAS:** 4 PIN / WITH IGNITION MODULE

**REPLACES / REEMPLAZA:**
**GM:** 12578224, 12638824;

**Denso:** 099700-0850;

**Wells:** C1552;

**Standard:** UF491

**APPLICATION / APLICACIÓN:**
**Chevrolet:** Captiva;

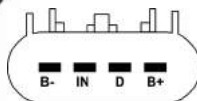
**Buick;**
**Pontiac**

**GM**
**GC4926 // NEW //**
**FEATURES / CARACTERÍSTICAS:** 6 PIN / WITHOUT IGNITION MODULE

**REPLACES / REEMPLAZA:**
**GM:** 10458316, 1104082, 11004082;

**Opel:** 1208021;

**Delphi:** CE20009-12B1;

**Fiat/Alfa Romeo:** 71739725, 71744369;

**Lucas:** DMB939;

**Valeo:** 245098

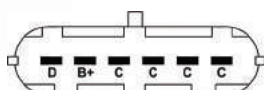
**APPLICATION / APLICACIÓN:**
**Chery; Peugeot; Citroën; Opel**

### GM/DAEWOO/FORD

### GC4020

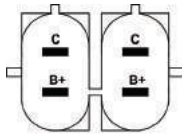

FEATURES / CARACTERÍSTICAS: 4 TERMINALS / WITHOUT IGNITION MODULE

REPLACES / REEMPLAZA:

GM: D-535, D-537, D-544, D-560, D-573, D-575, DR37X, AF5FU12029AA, 1115315, 1115316, 1115317, 1115466, 1115467, 1115468, 1115491, 10477208, 8983501871, 83501871; ISUZU: 8-01115-315-0, 8-01115-466-0, 806673T, 817378T

APPLICATION / APLICACIÓN:

GM /DAEWOO /FORD: Camaro, Caprice, Corvette, Storm, Impala, Fleetwood, Firebird, Cavalier 94-96, Skyhawk, Cimarron

### HITACHI

### GC4025

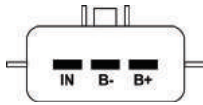

FEATURES / CARACTERÍSTICAS: 3 PIN / WITH IGNITION MODULE

REPLACES / REEMPLAZA:

NISSAN 22448-4M500, 22448-4M50A; HITACHI: CM11-205; MAZDA: 1N10-18-100; BERU: 0040102021; LUCAS: DMB856; BOSCH: 0986JG1211

APPLICATION / APLICACIÓN:

NISSAN: Sentra /Primera 99-08, Almera 1.5-1.8 00>08

### HITACHI

### GC4108

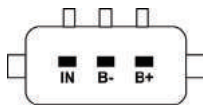

FEATURES / CARACTERÍSTICAS: 3 PIN / BACK / WITH IGNITION MODULE

REPLACES / REEMPLAZA:

Hitachi: CM11-108; Honda: 30521-PWA-003; Standard: UF374

APPLICATION / APLICACIÓN:

HONDA: Fit 1.4 8V 2004>2008

### HITACHI

### GC4109

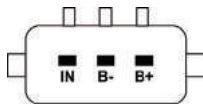

FEATURES / CARACTERÍSTICAS: 3 PIN / FRONT / WITH IGNITION MODULE

REPLACES / REEMPLAZA:

Hitachi: CM11-109; Honda: 30520-PWA-003 /30520ERA201; Standard: UF373

APPLICATION / APLICACIÓN:

HONDA: Fit 1.4 8V 2004>2008

### HITACHI

### GC4110

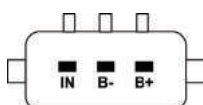

FEATURES / CARACTERÍSTICAS: 3 PIN /1 PART BY CYLINDER / WITH IGNITION MODULE

REPLACES / REEMPLAZA:

Hitachi: CM11-110, 5215C; Honda: 30520-PWC-003; Standard: UF581; Magneti Marelli: BI0029MM

APPLICATION / APLICACIÓN:

HONDA: Fit 1.5 16V 2009>

### HITACHI

### GC4325 // NEW //

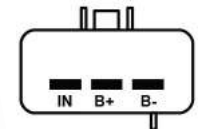

FEATURES / CARACTERÍSTICAS: 3 PIN / WITH IGNITION MODULE

REPLACES / REEMPLAZA:

Hitachi: 8971363250, 8970745540, 88921373, CM11-102.

APPLICATION / APLICACIÓN:

ISUZU: D-MAX 3.5 turbo, Amigo, Rodeo, Trooper, Vehicross;

ACURA: SLX

HONDA: Passport

### HITACHI

### GC4230 // NEW //

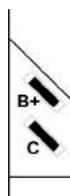

FEATURES / CARACTERÍSTICAS: 2 PIN / WITHOUT IGNITION MODULE

REPLACES / REEMPLAZA:

CM1T-230A

APPLICATION / APLICACIÓN:

NISSAN: Pathfinder 3.3 V6, Vehiclos 1996-2000 Motor 3.3 V6

**HYUNDAI**
**GC4023**
**FEATURES / CARACTERÍSTICAS:** 2 PIN / WITHOUT IGNITION MODULE

**REPLACES / REEMPLAZA:**
**KIA:** 27301-26640; **HYUNDAI:** 27301-26640, 03220-10874

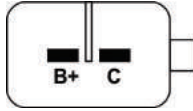
**APPLICATION / APLICACIÓN:**
**HYUNDAI:** Elantra 1.6W (2006~2007), Yuedong 1.6W (2006>), Accent 1.6W (2006>);  
**KIA:** Rio 1.6 CVVT 05-06, 09

**HYUNDAI**
**GC4274 // NEW //**
**FEATURES / CARACTERÍSTICAS:** 2 PIN / WITHOUT IGNITION MODULE

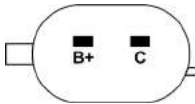
**REPLACES / REEMPLAZA:**
**Hyundai:** 27301-0400

**APPLICATION / APLICACIÓN:**
**HYUNDAI:** HB20 1.0 (Sedan/Hatch) 2012~2014; **KIA:** Morning 1.0 / 1.0 bi-fuel 2011~2014

**HYUNDAI**
**GC4277 // NEW //**
**FEATURES / CARACTERÍSTICAS:** 2 PIN / WITHOUT IGNITION MODULE

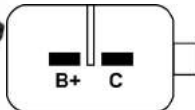
**REPLACES / REEMPLAZA:**
**Hyundai:** 27301-3C000

**APPLICATION / APLICACIÓN:**
**HYUNDAI:** AZERA 2.4 11/2006>, AZERA 3.3 V6 11/2006>, SANTA FÉ 3.3 V6 09/2006>, SONATA 2.0-2.4 12/2006>, SONATA 3.3 V6, VERA CRUZ 3.8 V6 10/2006>.

**KIA:** CARENS 2.0 10/2006>, CARNIVAL 2.7/3.5/3.8 V6 10/2006>, MOHAVE/BORREGO 3.8 V6 ALL, OPIRUS 3.8 V6 10/2006>, OPTIMA/MAGENTIS 2.0 4CC 09/2006>, SORENTO 3.3/3.5/3.8 V6 09/2006>.

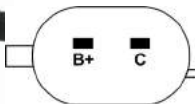
**HYUNDAI**
**GC4278 // NEW //**
**FEATURES / CARACTERÍSTICAS:** 2 PIN / WITHOUT IGNITION MODULE

**REPLACES / REEMPLAZA:**
**Hyundai:** 27300-2E000

**APPLICATION / APLICACIÓN:**
**Hyundai:** IX35, Sonata, Tucson;  
**Kia:** Cerato, Soul, Sportage

**HYUNDAI**
**GC4279 // NEW //**
**FEATURES / CARACTERÍSTICAS:** 2 PIN / WITHOUT IGNITION MODULE

**REPLACES / REEMPLAZA:**
**Hyundai:** 27301-3E400;

**Standard:** UF558

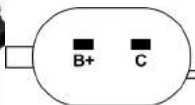
**APPLICATION / APLICACIÓN:**
**Hyundai:** Santa Fé 2.7 (4x4) V6 2006>2007;

**Kia:** Carnival, Optima 2007>2009, Rondo 2007>2009

**HYUNDAI**
**GC4280 // NEW //**
**FEATURES / CARACTERÍSTICAS:** 2 PIN / WITHOUT IGNITION MODULE

**REPLACES / REEMPLAZA:**
**Hyundai:** 27300-3F100;

**Standard:** UF611

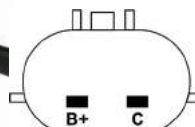
**APPLICATION / APLICACIÓN:**
**Hyundai:** IX35, Sonata, Sorento, Equus 2011, Genesis 2009>2010, Genesis Coupe 2010, Santa Fé 2010, Sonata 2008>2011, Tucson 2010>2011;

**Kia:** Borrego 2009>2011, Forte 2010, Rondo 2009>2010

**HYUNDAI**
**GC4281 // NEW //**
**FEATURES / CARACTERÍSTICAS:** 3 PIN / WITHOUT IGNITION MODULE

**REPLACES / REEMPLAZA:**
**Hyundai:** 27301-37410

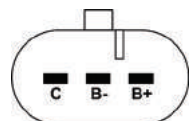
**APPLICATION / APLICACIÓN:**
**Hyundai:** Santa Fé GLS Sport 2007>

**Kia:** Optima EX,LX 2007>

### HYUNDAI

#### GC4282 // NEW //

FEATURES / CARACTERÍSTICAS: 3 PIN / WITH IGNITION MODULE

REPLACES / REEMPLAZA:

Hyundai: 27301-23400, 0324622194, 0119621278;

Champion: BAE 400D

APPLICATION / APLICACIÓN:

Kia: Carens

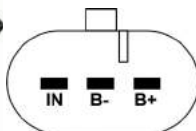

### HYUNDAI

#### GC4283 // NEW //

FEATURES / CARACTERÍSTICAS: 2 PIN / WITHOUT IGNITION MODULE

REPLACES / REEMPLAZA:

Hyundai: 27301-2B100

APPLICATION / APLICACIÓN:

Kia: Rio 1.6L 2012>, Soul 1.6L 2012>;

Hyundai: Accent 1.6L 2012>, Veloster 1.6L 2012>

Toyota: Altezza RS200

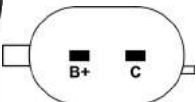

### HYUNDAI

#### GC4284 // NEW //

FEATURES / CARACTERÍSTICAS: 3 PIN / WITH IGNITION MODULE

REPLACES / REEMPLAZA:

Hyundai: 27301-3E100;

Standard: UF554

APPLICATION / APLICACIÓN:

Kia: Optima 2.7L V6 2007>2008;

Hyundai: Santa Fé 2.7L V6 2007

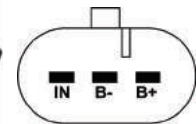

### HYUNDAI

#### GC4285 // NEW //

FEATURES / CARACTERÍSTICAS: 3 PIN / WITH IGNITION MODULE

REPLACES / REEMPLAZA:

Hyundai: 27300-39050;

Standard: UF-431, C01-27300-39800, PC98-27300-39050

APPLICATION / APLICACIÓN:

Hyundai: XE300 / 350 2001>2003, XG300 3.0L 2001, XG350 3.5L 2002;

Kia: Sedona 3.5L 2002>2005, Sorento 2003>2006.

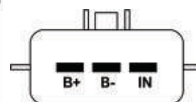

### HYUNDAI

#### GC4286 // NEW //

FEATURES / CARACTERÍSTICAS: 2 PIN / WITHOUT IGNITION MODULE

REPLACES / REEMPLAZA:

Hyundai: 27301-2B010

APPLICATION / APLICACIÓN:

HYUNDAI: I30 1.6 2007>; KIA: Cerato 1.6 2006>, Soul 1.6 2009>

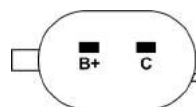

### HYUNDAI

#### GC4419

FEATURES / CARACTERÍSTICAS: 3 PIN / 2 COILS / WITHOUT IGNITION MODULE

REPLACES / REEMPLAZA:

Hyundai / KIA: 27301 - 23700, 27301-23710; USA Group: C1434, UF419; Wells: C1434; Standard: UF419; MD: 158956

APPLICATION / APLICACIÓN:

HYUNDAI: Elantra 2003>2006, Tiburon 2003>2008, Tucson L4-2.0L 2005>2009, Tucson 2.0 16V 2001>2004;

KIA: Spectra 2004>2009, Spectra5 2005>2009, Sportage L4-2.0L 2005>2007, Sportage 2.0 16V

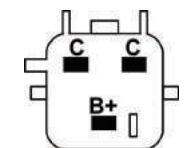

### KIA

#### GC4026

FEATURES / CARACTERÍSTICAS: 2 PIN / WITHOUT IGNITION MODULE

REPLACES / REEMPLAZA:

KIA: 0K013-18-100, 88921371, E501C; CHRYSLER / MITSUBISHI: MD362907; HYUNDAI: 0K01318100

APPLICATION / APLICACIÓN:

KIA: Sportage 95-02

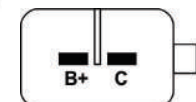

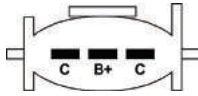
**MAGNETI MARELLI**
**GC4029**

FEATURES / CARACTERÍSTICAS: 3 PIN / WITHOUT IGNITION MODULE

REPLACES / REEMPLAZA:

988F-12029-AC; **Magneti Marelli**: BI005SSM

APPLICATION / APLICACIÓN:

**FORD**: Fiesta, Courier, Escort Zetec

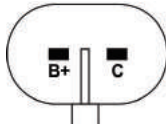
**MAGNETI MARELLI**
**GC4103**

FEATURES / CARACTERÍSTICAS: 2 PIN / WITHOUT IGNITION MODULE

REPLACES / REEMPLAZA:

**Bosch**: F 000 ZS0 103; **Champion**: BAE800B; **Cód. original**: 46548037; **Magneti Marelli**: 0780002010

APPLICATION / APLICACIÓN:

**FIAT**: Siena 1.3, 1.5 98-05, UNO 1.5 Spi, Mile Mpi 93-03 Fiorino 94-04, Elba 93- 96, Premio 92- 93, Palio 1.0, 1.5 8V 98-02, Strada 1.0/1.5 8V,TE

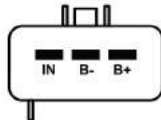
**MITSUBISHI**
**GC4562 // NEW //**

FEATURES / CARACTERÍSTICAS: 3 PIN / WITH IGNITION MODULE

REPLACES / REEMPLAZA:

**Mitsubishi / Suzuki**: 33400-65J0, H6T11371;

**Regitar**: RUF562

APPLICATION / APLICACIÓN:

**SUZUKI**: Grand Vitara 2006>2008 / SX4 2007>2009

**MITSUBISHI**
**GC4941 // NEW //**

FEATURES / CARACTERÍSTICAS: 3 PIN / WITH IGNITION MODULE

REPLACES / REEMPLAZA:

**Mitsubishi**: MD362907, MD366821, MD362913, MD325048, MD361710, MD362903;

**Regitar**: RUF141; **Standard**: UF295; **Bosch**: 0221503465; **Denso**: 099700-048;

**Hafei**: MD362903; **Lucas**: DMB1010

APPLICATION / APLICACIÓN:

**Mitsubishi**: Eclipse, Galant, Lancer, Mirage, Outlander;

**Chrysler**: Sebring;

**Dodge**: Stratus

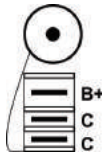
**MITSUBISHI**
**GC4966**

FEATURES / CARACTERÍSTICAS: 3 PIN / WITHOUT IGNITION MODULE

REPLACES / REEMPLAZA:

**Mitsubishi**: H3T024; **Mazda**: 155852, F69651971; **Regitar**: RUF966; **Diamond**: F-696 618393; **Standard**: UF371

APPLICATION / APLICACIÓN:

**MITSUBISHI**: Eclipse 1990>1995, Expo 1993>1994, Expo LRV 1992;

**MAZDA**: 626 1990>1996; **DODGE**: Colt 1993>1994;

**EAGLE**: Summit 1994>1994;

**PLYMOUTH**: Colt 1992>1994

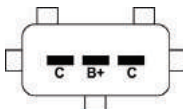
**MOTOROLA**
**GC4370 // NEW //**

FEATURES / CARACTERÍSTICAS: 3 PIN / WITHOUT IGNITION MODULE

REPLACES / REEMPLAZA:

**OEM**: S11-3705110JA, 101R42076X01, 01R43059X01

APPLICATION / APLICACIÓN:

**CHERY**: QQ

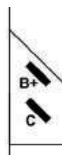
**NISSAN**
**GC4227**

FEATURES / CARACTERÍSTICAS: 2 PIN / WITHOUT IGNITION MODULE

REPLACES / REEMPLAZA:

CM1T-230, CM1T-227; **Nissan**: 22433-F4302

APPLICATION / APLICACIÓN:

**NISSAN**: 84-99

### NISSAN/TOYOTA

#### GC4027

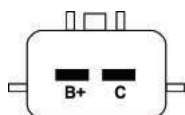

**FEATURES / CARACTERÍSTICAS:** 2 PIN / WITHOUT IGNITION MODULE

**REPLACES / REEMPLAZA:**

**NISSAN:** 22433-53F00, 22433-55Y00, 22433-65Y10, 22448-1C701, 22448-37J10, 22448-37J20, 22433-65Y1093

**APPLICATION / APLICACIÓN:**

**TOYOTA:** Serena 1.6 16V 88-97;

**NISSAN:** Patrol 88-97

### PEUGEOT

#### GC4034

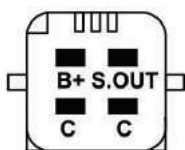

**FEATURES / CARACTERÍSTICAS:** 4 PIN – GRAY CONECTOR / 1 POLARIZER / WITHOUT IGNITION MODULE

**REPLACES / REEMPLAZA:**

**CITROËN:** 597078, 597078+596319, 597079, 597079+596319, 5970A8, 96358648, 96358649; **Peugeot:** 597078, 597078+596319, 597079, 59707 9+596319, 5970A8, 96358648, 96358649; **Bougicord:** 154302

**APPLICATION / APLICACIÓN:**

**CITROËN:** Berlingo 1.1i/1.4i 06/00>12/02, C2 1.1 /1.4 09/03, C3 1.1i 02/02 /1.4i Bivalent 02/02>12/05, C3 Pluriel 1.4 05/03, Saxo 1.0X /1.1X /1.1SX /1.4VTS 06/00>12/02;

**XSara** 1.4i 06/00>12/05 /Break 1.4i 06/00>08/05 /Coupé 1.4i 06/00>03/05;

**PEUGEOT:** 106 II 1.1i/1.4i 06/00, 107 1.3 06/06, 206 1.1i 06/00, 206 1.4i 06/00>12/05, 206 SW 1.1 /1.4 07/02, 206 SW /1.4 16V 10/03, 306 1.4 06/00>12/05, 306 1.4 SL 06/00>05/01, 306 Break 1.4 06/00>12/05, 307 1.4 08/00>12/05, 307 Break /SW 1.4 16V 11/03, 1007 1.4 04/05, Partner 1.1 /1.4 /1.1 /1.4 Combispace 06/00>12/05

### PEUGEOT

#### GC4054

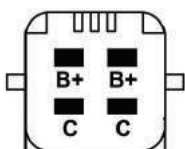

**FEATURES / CARACTERÍSTICAS:** 4 PIN / BLACK CONECTOR / 2 POLARIZERS / WITHOUT IGNITION MODULE

**REPLACES / REEMPLAZA:**

**PEUGEOT:** 597072, 597074, 9628158580, 596319; **CITROËN:** 597072, 597074, 9628158580, 96246755, 96281585;

**SAGEM:** 2526117A, 25261174; **VALEO:** 245109; **LUCAS:** DMB812; **BOSCH:** 0986221034; **BOUGICORD:** 154301;

**PSA:** 597072, 5970A9, 9624675580, 9628158580

**APPLICATION / APLICACIÓN:**

**PEUGEOT:** 106 /307 /206 1.4i, 1.6i 8V 98-00, 306 1.4 /1.4SL /1.6 /1.6SR 8V 97-00, 306 Break 1.4 /1.6 8V 97-00, 306 Cabrioler 1.6 8V, 406 1.6 8V 97-00, Partner 1.6 8V 00>;

**CITROËN:** C2/C3 1.1,1.4 02-03;SAXO(S0,S1) 1.0X/XS/VTS/VTL/VTR 96-03;XSARA/PICASSO 1.4i,1.6i 97-99

### PEUGEOT

#### GC4074

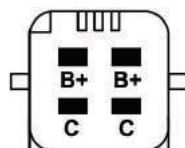

**FEATURES / CARACTERÍSTICAS:** 4 PIN – BLACK CONECTOR / 1 POLARIZER / WITHOUT IGNITION MODULE

**REPLACES / REEMPLAZA:**

**Citroën:** 597090, 597097, 9654347080; **Peugeot:** 597090, 597097, 9654347080; **Bougicord:** 154303.

**APPLICATION / APLICACIÓN:**

**CITROËN:** Berlingo 1.1i/1.4 bivalent /1.4i bivalent 01/05, C2 1.1 /1.4 01/05, C3 1.4i 02/02, C3 Pluriel 1.4 05/05;

**PEUGEOT:** 207 1.4 02/06, 207 SW 1.4 06/07, 1007 1.4 04/05, Partner 1.1 /1.4 /1.4BiFuel /Combispace 1.1 /1.4 01/05;

### PEUGEOT

#### GC4094 // NEW //

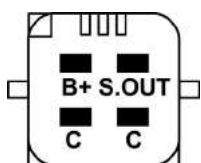

**FEATURES / CARACTERÍSTICAS:** 4 PIN / WITHOUT IGNITION MODULE

**REPLACES / REEMPLAZA:**

**Peugeot / Citroën:** 5970A8, 5970A9, 597097, 597090, 9654347080, 9467511580;

**Valeo:** 9654814480, 26951960-3, 245103;

**Standard:** IIS197, 12796

**APPLICATION / APLICACIÓN:**

**Citroën:** C3 2009>, C2 2003>, Berlingo 1.4 1996>, Nemo 1.4 2008>;

**Peugeot:** Ranch 1.4 1996>, 206 1.4 1998>, 207 1.4 2007>, Bipper 1.4 2008>, Tepee 1.4 2008>

### RENAULT

#### GC4131

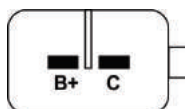

**FEATURES / CARACTERÍSTICAS:** 2 PIN / WITHOUT IGNITION MODULE

**REPLACES / REEMPLAZA:**

**Renault:** 7700875000; **Bosch:** 0986221001

**APPLICATION / APLICACIÓN:**

**RENAULT:** Clio/ Sedan, 1.6 16V Hi Flex 04>, Scenic 1.6 1.6V Hi Flex 05>, Megane/ Grand Tour 1.6 16V 06>, Kangoo 1.6 16V 07>, Logan 1.6 16V 07>

### BOSCH

#### GC4132 // NEW //

FEATURES / CARACTERÍSTICAS: 2 PIN / WITHOUT IGNITION MODULE

REPLACES / REEMPLAZA:

Renault: 82007658 82, 7700875000, 78419001, 7700107177, 7700113357, 7700113357A, 0040100052, 8200208611, 8200154186, 8200154186A, 8200380267, 029700-8291, 21595273-2, 2526181A;

Valeo: 21603121-9, 245104;

Lucas: DMB804;

Bosch: 0986221001;

Nissan: 22448-00QAA, 22448-00QAC, 22448-00QAE;

Opel: 91159996, 4408389

APPLICATION / APLICACIÓN:

Renault: Clio, Kangoo, Livina, Logan, Sandero 1.6 16V, Avantime, Espace, Grand Scenic, Laguna, Megane, Modus, Thalia, Trafic II, Vel Satis;

Vauxhall: Vivaro;

Dacia: Logan;

Morgan: Plus Four;

Nissan: Kubistar, Primastar;

Opel: Vivaro

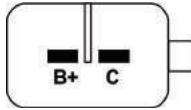

### RENAULT

#### GC4221

FEATURES / CARACTERÍSTICAS: 4 PIN / WITHOUT IGNITION MODULE

REPLACES / REEMPLAZA:

Bosch: F 000 ZS0 221; Renault: 7700274008, 7700873701

APPLICATION / APLICACIÓN:

RENAULT: Clio, Kangoo, Twingo 1.0, 1.6 8V (motor D7D 760) 00>, Logan 1.0, 1.6 8V (motor D&D 740) 02>

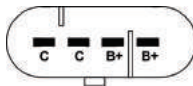

### RENAULT

#### GC4269

FEATURES / CARACTERÍSTICAS: 3 PIN / WITHOUT IGNITION MODULE

REPLACES / REEMPLAZA:

Renault: 7700107269; Bosch: 0986 221033

APPLICATION / APLICACIÓN:

RENAULT: Scenic 2.0 96-03/ Megane 2.0 97-03

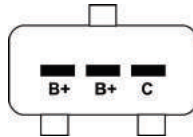

### RENAULT

#### GC4401

FEATURES / CARACTERÍSTICAS: 4 PIN / WITHOUT IGNITION MODULE

REPLACES / REEMPLAZA:

Renault: 8200084401; Peugeot: 598083

APPLICATION / APLICACIÓN:

PEUGEOT: 206 1.0L 16V 00>;

RENAULT: Clio, Kangoo, Twingo 1.0 16V (gasolina) 06/01>06/04, Kangoo Express 1.0 16V 10/01>06/04

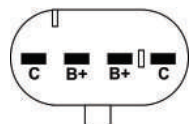

### RENAULT

#### GC4408 // NEW //

FEATURES / CARACTERÍSTICAS: 4 PIN / WITHOUT IGNITION MODULE

REPLACES / REEMPLAZA:

Renault: 8200702693, H8200734204 - 77040001;

Bougicord: 151408

APPLICATION / APLICACIÓN:

Renault: Clio 1.0 16V (Hi-Flex) 01/09>, Kangoo 1.0 16V (Hi-Flex) 1/09>, Twingo 1.0 16V (Hi-Flex) 01/09>, Sandero, Logan;

Peugeot: 1.0 16V Flex D4D 2013>.

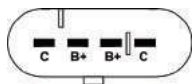

### RENAULT

#### GC4911

FEATURES / CARACTERÍSTICAS: 4 PIN / WITHOUT IGNITION MODULE

REPLACES / REEMPLAZA:

Renault: 8200360911

APPLICATION / APLICACIÓN:

RENAULT: Clio, Kangoo 1.0 16V (Hi-Flex) 07/04>12/08, Twingo 1.0 16V (Hi-Flex) 08/04>12/08

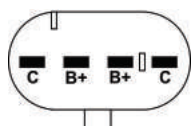

### RENAULT

### GC4022

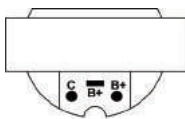

**FEATURES / CARACTERÍSTICAS:** 3 TERMINALS / WITHOUT IGNITION MODULE

**REPLACES / REEMPLAZA:**

**RENAULT:** 7701031135, 7701030273, 33002299, 12336238; **MAGNETI MARELLI:** BAE504B; **VALEO:** 245054, DMB823; **SAGEM:** 2526023, 2526048; **BOSCH:** F-000-ZS0-115; **BERU:** 0040100316, ZS316; **LUCAS:** DLB204, DMB823; **VOLVO:** 3287677, 3287677-3

**APPLICATION / APLICACIÓN:**

**RENAULT:** R19 /R21 1.8 /2.0 /Laguna 2.0 84-92

### TOYOTA

### GC4028

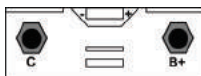

**FEATURES / CARACTERÍSTICAS:** 3 TERMINALS / WITHOUT IGNITION MODULE

**REPLACES / REEMPLAZA:**

**TOYOTA** 90919-02163; **GM:** 94855502; **LUCAS:** DMB949; **BOSCH:** F000ZS0121; **ROOTS:** 0880016

**APPLICATION / APLICACIÓN:**

**TOYOTA:** Camry 2.2 92-95, Rav 4 2.0 16V 96>, Corolla 95-97

### TOYOTA

### GC4024

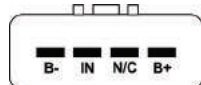

**FEATURES / CARACTERÍSTICAS:** 4 PIN / WITH IGNITION MODULE

**REPLACES / REEMPLAZA:**

**TOYOTA:** 90919-02240, 90080-19021, 90919-T2003; **LUCAS:** DMB902; **STANDARD:** UF-316

**APPLICATION / APLICACIÓN:**

**TOYOTA:** Corolla / Fielder 01-06, Prius 1.5 00>09, Yaris 99>11

### TOYOTA

### GC4253 // NEW //

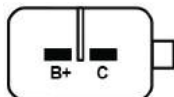

**FEATURES / CARACTERÍSTICAS:** 2 PIN / WITHOUT IGNITION MODULE

**REPLACES / REEMPLAZA:**

**TOYOTA:** 90919-02215, EZX-147A, 88921336, 9008019012, E588; **Standard:** UF-155; **Wells:** C1040

**APPLICATION / APLICACIÓN:**

**TOYOTA:** Camry 95, Solara, Avalon

### TOYOTA

### GC4135 // NEW //



**FEATURES / CARACTERÍSTICAS:** 2 PIN / WITHOU IGNITION MODULE

**REPLACES / REEMPLAZA:**

**Toyota:** 90919-02135, 90919-02139, 90919-02196, 90919-02152; **Vag:** J9091902139; **VW:** J9091902139; **Standard:** UF40

**APPLICATION / APLICACIÓN:**

**CHEVROLET:** Nova 85>88, Geo Prizm 90>92; **TOYOTA:** Camry 83>91, Celica 86>93, Celica Coupe 1989>1994, VAN 84>89, VAN Wagon 1988, Carina II 1987>1993, Carina II Saloon 1987>1993, Carina II Station Wagon 1987>1992, Corolla 1983>1989, Corolla 1987>1994, Corolla 1.6 i Saloon 89>93, Corolla Compact 1987>1995, Corolla Compact 1.6 i Hatchback 89>92, Corolla Liftback 1983>1989, Corolla Liftback 1.6 Hatchback 85>87, Corolla Liftback 1987>1995, Corolla Liftback 1.6 Hatchback 89>92, Corolla Station Wagon 1987>1992, Corolla Station Wagon 1.6 Estate 89>92, Hilux II Pickup 1982>2005, Hilux II Pickup 1.8, Pickup 88>94, Hilux II Pickup 2.2 4WD Pickup 87>89, Liteace Box 1992>1995, Liteace Box 2.2 Box 92>95, Liteace Bus 1992>1998, Liteace Bus 2.2 Bus 92>95, Modell F Bus 1982>1990, Modell F Bus 2.0 Bus 88>90, Modell F Bus 2.2 Bus 87>90, Tercel 1982>1988, Tercel 1.5 4WD Hatchback 86>88; **VOLKSWAGEN:** Taro 1989>04 - 1997>03, Taro 1.8 Pickup 89>94, Taro 2.2 Pickup 89>94.

### UNIVERSAL

### GC4018

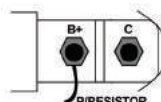

**FEATURES / CARACTERÍSTICAS:** 3 TERMINALS / WITHOUT IGNITION MODULE

**REPLACES / REEMPLAZA:**

**Universal** ( replaces all coils by oil);

**Suzuki:** 33410-85120, MIC-2000, FTM-063GTGC-5; **Toyota:** GC-5; **Diamond:** F-076

**APPLICATION / APLICACIÓN:**

**HYUNDAI;**  
**SUZUKI;**  
**VW;**  
**FORD;**  
**FIAT**

**VALEO**

**GC4064**

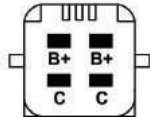

**FEATURES / CARACTERÍSTICAS:** 4 PIN / 2 POLARIZERS / WITHOUT IGNITION MODULE

**REPLACES / REEMPLAZA:**

**Valeo:** 245098, 2526118, 2526118A; **Peugeot / Citroën:** 597098, 597075, 94632641, 96341314, 96632641, 9634131480; **Fiat:** 9663264180, 9634131380, 9634131490; **Lucas:** DMB866; **Beru:** 0040100348

**APPLICATION / APLICACIÓN:**

**CITROËN:** C4 2.0 16V, C5 1.8 16V /2.0 16V, C8 2.0 16V, Evasion 2.0 16V, Xsara 2.0 16V, Xsara Picasso 1.8 16V 2005 /2.0 16V 2005; **PEUGEOT:** 307 2.0 16V 2005, 406 1.8 16V /2.0 16V, 407 1.8 16V /2.0 16V, 807 1.8 16V /2.0 16V

**VW**

**GC4097**



**FEATURES / CARACTERÍSTICAS:** 6 PIN / WITH IGNITION MODULE

**REPLACES / REEMPLAZA:**

UF484; **VW/SKODA:** 06A 905 097, 06A 905 104, 06A905097, 0040102029, 905100004

**APPLICATION / APLICACIÓN:**

**VW AUDI:** Bora 2.0i 98>05, Golf IV 2.0i 98>06, New Beetle 2.0i 98>10, Touran 06>09; Santana 3000, Voyage /Saveiro /Gol 1.0 VHT G5 2010>; **SKODA:** Octavia 2.0i

**VW**

**GC4098**

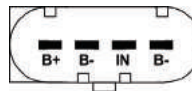

**FEATURES / CARACTERÍSTICAS:** 4 PIN / WITH IGNITION MODULE

**REPLACES / REEMPLAZA:**

**VW:** 030 915 110 B

**APPLICATION / APLICACIÓN:**

**VW:** Gol VI, Novo Fox, Voyage G6, Saveiro G6

**VW**

**GC4215 // NEW //**

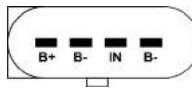

**FEATURES / CARACTERÍSTICAS:** 4 PIN / WITH IGNITION MODULE

**REPLACES / REEMPLAZA:**

**VW / Audi:** 06F905115, 06F905115A/B/C/D/E/F, 07K905715, 07K905715A/B/C/D/E/F, 06H905115, 06H905115A/B/, 0221604115.

**APPLICATION / APLICACIÓN:**

**VW:** Passat, Jetta 2.0 FSI, Jetta Variant 1.8/2.0 2005>2010, Tiguan 2.0 2007>, Touareg 4.2 V8 FSI 2006>, Golf V; **Audi:** A3, A4, A5, A6, R8, TT, Q5, Q7 TSFI; **Seat:** Toledo III

**VW / FORD**

**GC4104**

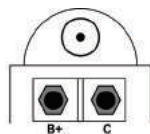

**FEATURES / CARACTERÍSTICAS:** 2 PIN / WITHOUT IGNITION MODULE

**REPLACES / REEMPLAZA:**

**VW:** 867.905.104-A;

**APPLICATION / APLICACIÓN:**

**VW:** Golf III 1.8, 2.0 94- 98, Polo Classic 1.6, 1.8 Mi 98-03

**VW / FORD**

**GC4105**

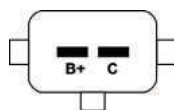

**FEATURES / CARACTERÍSTICAS:** 2 PIN / WITHOUT IGNITION MODULE

**REPLACES / REEMPLAZA:**

547.905.105B; **Bosch:** F000ZS0102

**APPLICATION / APLICACIÓN:**

**FORD:** Escort 1.6, 1.8 2.0 XR3, 94-96, Pampa 1.896-97, Versailles/ Royale, 97-96, Verona 1.8i, 2.0i 94-96; **VW:** Gol II 1.0, 1.6, 1.8, 2.0, 94-97, Logus 1.6, 1.8, 2.0, 94-96, Parati II 1.6, 1.8, 2.0, 95-96, Pointer, 1.8, 2.0 94-96, Santana/ Quantum 2.0, 94-96

**VW / FORD**

**GC4002**



**FEATURES / CARACTERÍSTICAS:** 6 PIN / WITH IGNITION MODULE

**REPLACES / REEMPLAZA:**

**Bosch:** 0 221 601 002; **Magneti Marelli:** BI0018MM; **VW:** 54.790.510.4B

**APPLICATION / APLICACIÓN:**

**FORD:** Escort, Verona; **VW:** Gol 1000, Passat, Voyage 1.6, 1.8

